

Neuro-Fuzzy Controller and Bias Voltage Generator Aided UPQC for Power Quality Maintenance

M. Vishnuvardhan and Dr. P. Sangameswararaju

Abstract—Power quality (PQ) of power operating device is one of today's most discussed topic but also it is a most problematic subject in recent years. The increasing application of power operating device can cause PQ disturbances. Avoiding the PQ disturbance and enhancing the PQ are the difficult tasks. More power electronics devices are used to overcome the PQ disturbances. Unified power quality conditioner (UPQC) is one of the power electronics devices that are used for enhancing the PQ. It consists of two voltage source inverters (VSIs) and sharing with one DC link capacitor. The discharging time of DC link capacitor is very high, and so it is the main problem in UPQC device. To eliminate this problem, an enhanced Neuro-fuzzy controller (NFC) based UPQC is proposed in this paper. The DC link capacitor discharging time is eliminated by installing a bias voltage generator. The input of bias voltage generator is generated by using a NFC. NFC is the combination of neural network (NN) based controller and fuzzy logic controller (FLC). Initially, the error voltage and change of error voltage of a nonlinear load is determined. Then the voltage variation is applied separately to FLC and NN-based controller. The output voltage of FLC and NN-based controller is calculated, and then the mean voltages of the two methods are applied to the bias voltage generator and finally, the PQ of the system is enhanced. The proposed controller is tested and the results of tested system and their performances are evaluated.

Index Terms—Power quality (PQ), unified power quality conditioner (UPQC), neuro-fuzzy controller (NFC), bias voltage generator, error

I. INTRODUCTION

PQ studies have emerged as a significant topic because of the extensive use of sensitive electronic equipments [1]. A broad definition of power quality that includes the definitions of technical quality and supply continuity states that the limits specified in the standards and regulations should not be exceeded by electrical PQ or in other words frequency, number and interval of interruption, interruption in voltage, sine waveform and voltage unbalance [2]. Nowadays power quality is definitely a big issue and the inclusion of advanced devices, whose functioning is extremely sensitive to the quality of power supply, makes it especially important [3]. Due to the increasing anxiety over supplying pure electrical energy to the consumers in the availability of non-sinusoidal waveforms, PQ has gained much interest in recent years. [4].

Huge number of non-linear loads and generators on the

grid, especially systems based on power electronics like variable speed drives, power supplies for IT-equipment and high efficiency lighting and inverters in systems producing electricity from renewable energy sources have made electrical energy systems, voltages and specifically currents extremely irregular [5]. Degradation or impairment can occur in the electrical equipments connected to the system as a result of poor PQ [6]

The increased anxiety has resulted in measurement of changes in PQ, analysis of power disturbance characteristics and generation of solutions to the PQ problems [7]. Any apparent problem in voltage, current that gives rise to any frequency variations leading to breakdown or malfunction of customer equipment is termed as the PQ problem [8][9]. A PQ problem can be caused by several events. As a switching operation within the facility to a power system may be associated with the cause of a fault event located hundreds of miles away from that place, analysis of these events is frequently difficult [10]. PQ problems include short disruptions, long disruptions, voltage sags and swells, harmonics, surges and transients, unbalance, flicker, earthing defects and electromagnetic compatibility (EMC) problems [11]. Undesirable effects like extra heating, intensification of harmonics because of the existence of power factor correction capacitor banks, decrease of transmission system efficiency, overheating of distribution transformers, disoperation of electronic equipment, improper functioning of circuit breakers and relays, incorrectness in measuring device, interference with communication and control signals etc are caused by these PQ problems [12], [13].

Lessening the PQ problems and supporting the functioning of sensitive loads are possible because of power electronics and advanced control technologies [14]. The quality and reliability of electric power distribution systems are reported to be improved by custom power devices (CPDs). Three major CPDs are D-statcom, DVR and UPQC [15]. One of the foremost custom power devices that are competent of alleviating the consequence of power quality problems at the non linear load is the UPQC [16][17]. In addition to removal of harmonics, recompense for reactive power, load current unbalance, source voltage sags, source voltage unbalance and power factor correction are provided by UPQCs[18], [19]. In power distribution systems or industrial power systems, UPQC has the outstanding potential to enhance the quality of voltage and current at the position of installation [20].

Generally, an UPQC is comprised of two voltage source inverters (VSIs) sharing with one DC link capacitor. Here, the main problem is that the discharging time of DC link capacitor is very high. To mitigate this problem, an enhanced NFC based UPQC is proposed and detailed in

Manuscript received August 30, 2011; revised December 10, 2011.

Authors are with the Department of Electrical and Electronics Engineering, S.V. University, Tirupathi, Andhra Pradesh (e-mail: vishnuap9@yahoo.com, vishnuvardhanphd@gmail.com).

Section III. Prior to that, a concise review about the recently available related works are given in Section II. Section IV discusses and analyzes the results of the proposed controller and the Section V concludes the paper.

II. RELATED RECENT RESEARCHES: A BRIEF REVIEW

Numerous research works already exist in the literature that compensate power quality problem in power operating system. Some of them are reviewed here.

Ahmad esfandiari *et al.* [21] have proposed a new grouping of series and shunt active filters for an electric arc furnace to enhance its supply system PQ. Reactive power, harmonics, interharmonics, and imbalance have been compensated by the compensator which suppresses the PCC voltage and load current disturbances. Successful management of high source current by the series active filter and dissociation of the controls of the series and shunt active filters have been the merits of the proposed configuration. While one of the series inverters has been to function at high-current low-frequency, the other one has been for low-current high-frequency. Thus, based on switching frequency and current rating, proper switches could be chosen for the inverters. A new technique to function efficiently in the presence of PCC voltages contaminated with low frequency inter-harmonics has also been proposed for extracting the voltage reference signals. Efficient performance has been exhibited by the voltage and current compensating signals identification techniques for the series and shunt active filters.

Amit Kumar Jindal *et al.* [22] have proposed a new connection for a UPQC to enhance the power quality of two feeders in a distribution system. A series voltage-source converter (VSC) and a shunt VSC connected by a common dc bus exists in the UPQC. The manner in which this device is connected for simultaneously controlling both the bus voltage of one of the feeders and the voltage across a sensitive load in the other feeder has been demonstrated. This connection of the UPQC would be termed as an interline UPQC (IUPQC), because the UPQC has been connected between two different feeders (lines). They have discussed about the structure, control and capability of the IUPQC. Through simulation analysis using PSCAD/EMTDC, the effectiveness of the proposed configuration has been validated.

Lachman *et al.* [23] have proposed a Wavelet Transform technique for studying PQ disturbances. They have discussed and deliberated Waveform distortion type of PQ disturbances. Diverse kinds of signals have been created and diverse frequency bands have been acquired in the calculation process. It has been observed that identification of PQ disturbances necessitates selection of appropriate mother. It has been concluded that detection of PQ disturbances is made easier by the use of approximate coefficients and scaling. Wavelet Transform has been proved to be an appropriate tool for examining PQ disturbances, when time-frequency information is needed simultaneously by means of computational results.

Radhakrishnan *et al.* [24] have proposed a Fuzzy logic controller (FLC) for improving the power quality indices of

an AC-AC Conversion System as well as controlling its steady state and transient state output voltage. The Fuzzy response verified by means of PI action has been proved to be appropriate for utilization in Power Converters. The merits of the individual methods have been illustrated by comparing the performance of three firing schemes. The applicability of Sinusoidal Pulse Width Modulation (SPWM) over a wide range of applications has been demonstrated by sufficiently emphasizing the fact that it inherits numerous exclusive merits. As Random PWM (RPWM) considerably reduces the magnitude of harmonic components in addition to decreasing the filtering necessities it adapts itself for high power applications by its ability of spread its harmonic power. They have anticipated that such an analysis together with the advantages of the proposed FLC will go a long distance in nourishing new applications for AC-AC conversion systems although the option of a specific scheme could only be determined by specific needs.

Darly Sukumar *et al.* [25] have discussed a fuzzy algorithm based new method for attenuating the current harmonic contents in the output of an inverter. Ride-through capability amidst voltage sags, decreased harmonics, better power factor and high reliability, reduced electromagnetic interference noise, reduced common mode noise and increased output voltage range have been provided by the inverter system that uses fuzzy controllers. A model of three-phase impedance source inverter designed and managed based on the proposed considerations has been constructed and a practicable test has been implemented. The improved effectiveness and suitability of these new methods to reduce harmonics and increase the power quality have been verified from the practical point of view. A compromise between cost and performance has been frequently required in the realization because of the complexity of the algorithm. Variable-frequency DC-AC inverters, UPSs, and ac drives have applications for the proposed optimizing strategies.

Yash Pal *et al.* [26] have proposed a control strategy for a three-phase four-wire UPQC for an enhancement of different PQ problems. The UPQC is accomplished by the integration of series and shunt active power filters (APFs) and both APFs share a common dc bus capacitor. The shunt APF is realized by means of a three-phase, four leg voltage source inverter (VSI) and the series APF is realized by means of a three-phase, three legs VSI. A unit vector template technique (UTT) based control method has been used to obtain the reference signals for series APF, whereas the ICos Φ theory has been used for the control of Shunt APF. The performance of the implemented control algorithm has been evaluated in terms of power-factor correction, load balancing, source neutral current mitigation, voltage and current harmonics mitigation, mitigation of voltage sag and swell, and voltage dips in a three-phase four-wire distribution system under diverse combination of linear and non-linear loads. In the control system, the current/voltage control has been applied on the fundamental supply currents/voltages rather than fast changing APFs currents/voltages, and thus the computational delay and the required sensors has been reduced. The simulation results have been obtained using the MATLAB/Simulink and it proves that the proposed control system could maintain the functionality of the UPQC.

M. Siahi *et al.* [27] have proposed a design of combined operation of UPQC and PV array. Their proposed system is composed of series and shunt inverters, PV array and DC/DC converter which have capable for compensating the voltage sag, swell, interruption, harmonics and reactive power in both islanding and interconnected modes. The benefits of their proposed system are 1) it reduces the expense of PV interface inverter connected to grid by applying UPQC shunt inverter and 2) it has the ability of compensating the voltage interruption using UPQC because of connecting PV to DC link. In the proposed system, P&O technique has been used to reach the maximum power point of PV array. PSCAD/EMTDC software has been used for analyzing operation of the proposed system and the simulation results have proved that their proposed system operates correctly.

III. PQ MAINTENANCE TECHNIQUE USING NFC BASED PROPOSED UPQC

PQ is one of the most important factors in power operating devices, which determine the device operating condition. If the system maintains the PQ, it will provide stable operation or else it provides unstable operation. So maintaining of PQ is an essential one in power operating device. There are many devices such as dynamic voltage restorer (DVR), uninterruptible power supplies (UPS) and etc. used for maintaining the quality power supply. But, these devices maintain only the symmetrical or unsymmetrical power supplies, so the power quality is not maintained at all time. To avoid this problem, an enhanced NFC based UPQC is proposed in this paper. UPQC is one of the most significant devices for maintaining the PQ. In the UPQC, there are two VSI that share one D.C. link capacitor. The output of VSI depends on the discharging time of D.C. link capacitor. The discharging time of the capacitor is increased because the capacitor has high leakage current [28]. So, in this paper the D.C. link capacitor is removed and instead of that, a bias voltage generator is installed. The structure of proposed NFC based UPQC is illustrated in Fig. 1.

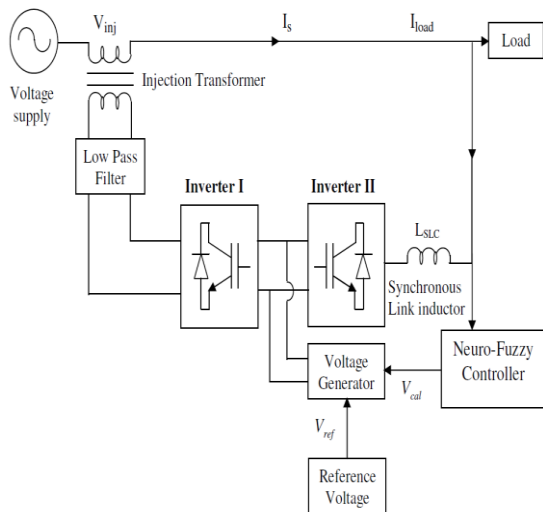

Fig. 1. General structure of proposed upqc controller.

The general structure of proposed NFC based UPQC consists of two inverters and it is connected with a bias voltage generator. The inputs of the bias voltage generator

are reference voltage (V_{ref}) and the voltage (V_{cal}), which is calculated from NFC. The Inverter II is connected in series with an inductance that is denoted by L_{SLC} . The purpose of the synchronous link inductor is to generate a voltage with respect to PQ disturbance. The inverter I is connected in series with a low pass filter and the purpose of the filter is pass the low frequency component, and to reduce the high frequency component of specific voltage signal. Then, the output of low pass filter is applied to voltage injection transformer. Hence, the obtained output from injection transformer is maintains PQ in the operating system. The injected line voltage, voltage source, current source and load current are denoted as V_{inj} , V_s , I_s and I_{load} . The V_{inj} can be determined as follows

$$V_{inj} = \sqrt{V_{s1}^2 - V_{s2}^2} \quad (1)$$

$$V_{inj} = \frac{mV_{dc}}{2\sqrt{2}} \quad (2)$$

where, V_{s1} is the pre voltage variation,

V_{s2} is the post voltage variation,

m is the modulation index,

V_{dc} is the normal rated dc voltage.

The output voltage and current of single phase system can be expressed as follows.

$$V_{output} = A \sin(\omega t + \theta) \quad (3)$$

$$I_{output} = I_s \cos \omega t \cos \theta \quad (4)$$

where, A is the amplitude of output voltage,

ω is the angular frequency,

θ is the phase angle of output voltage at $t=0$.

Using Eq. 3 and 4 the sinusoidal output voltage and current are calculated. The PQ of the supply is mainly depends on the output voltage of the system. Hence, in the paper the PQ of the system output voltage is maintained only during the time of system operation. Here, the voltage discharge capacitor of conventional UPQC is replaced by the bias voltage generator. As stated earlier, one of the inputs of the bias voltage generator V_{cal} is generated by NFC. The generation of V_{cal} is described as follows.

A. Bias Voltage Generation Using NFC

NFC is the combination of Fuzzy Inference System (FIS) and NN. The fuzzy logic is operated based on fuzzy rule and NN is operated based on training dataset. The neural network training dataset are generated from the fuzzy rules. The error voltage and change of error voltage of the device is determined as follows

$$error \ e(n) = V_{dc}(ref) - V_{dc} \quad (5)$$

$$change \ of \ error \ (\Delta e) = e(n) - e(n-1) \quad (6)$$

where, $e(n-1)$ is the previous state error. The error voltage and change of error voltage are calculated by using the above formula and the value are applied to the input of NFC. From the output of NFC, the V_{cal} is determined. The function of NFC is explained in the below section.

Stage 1: Bias Voltage Generator Using FLC

FLC plays an important role in PQ enhancement research

area [25]. In the fuzzy control scheme, the operation of controller is mainly based on fuzzy rules, which are generated using fuzzy set theory. The stages of fuzzy controller are fuzzification, decision making and defuzzification. Fuzzification is the process of changing crisp value into fuzzy value. The fuzzification process has no fixed set of procedure and it is achieved by different types of fuzzifiers. The shapes of fuzzy sets are triangular, trapezoidal and etc. In this paper, triangular fuzzy set is used. The fuzzified output is applied to the decision making process, which consists of set of rules. Using the fuzzy rules, the input of bias voltage generator is selected from FIS. Then, the defuzzification process is applied and the fuzzified calculated voltage (V_{cal}^F) is determined. Defuzzification is the inverse process of fuzzification. The structure of designed FLC is illustrated in Fig. 2 and the steps for designing FLC are pointed below

- The control variable of the power operation device is selected.
- Determine the ‘ $e(n)$ ’ and ‘ Δe ’ value of the system.
- Set the fuzzification process.
- Design the decision making rules.
- Set the defuzzification process.
- Test the output of power operating device.

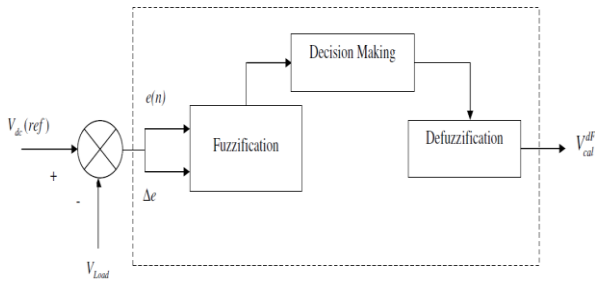

Fig. 2. Structure of FLC.

The inputs of FLC are $e(n)$, Δe and the output is V_{cal}^F .

The linguistic variables of $e(n)$, Δe and V_{cal}^F are Negative Big, Negative Medium, Negative Small, Zero, Positive Small, Positive Medium, Positive Big and it is referred as NB, NM, NS, ZE, PS, PM, PB in the rules base. The developed fuzzy rules are tabulated in TABLE I. Using the fuzzy rules, the V_{cal}^F is determined.

TABLE I: FUZZY RULES FOR DETERMINING V_{cal}^F

$e(n)$ Δe	NB	NM	NS	ZE	PS	PM	PB
NB	NB	NB	NB	NB	NM	NS	ZE
NM	NB	NB	NB	NM	NS	ZE	PS
NS	NB	NB	NM	NS	ZE	PS	PM
ZE	NB	NM	NS	ZE	PS	PM	PB
PS	NM	NS	ZE	PS	PM	PB	PB
PM	NS	ZE	PS	PM	PB	PB	PB
PB	ZE	PS	PM	PB	PB	PB	PB

Stage 2: Bias Voltage Generator Using NN

NN is an artificial intelligence technique that is used for generating training data set and testing the applied input data [29]. A feed forward type NN is used for the proposed method. Normally, the NN consist of three layers: input layer, hidden layer and output layer. The input layer consist of two inputs i.e. $e(n)$ and Δe . The output of the NN is network calculated voltage and it is denoted as V_{cal}^{NN} . The process of NN is performed in the hidden layer. The structure of NN is illustrated in Fig.3.

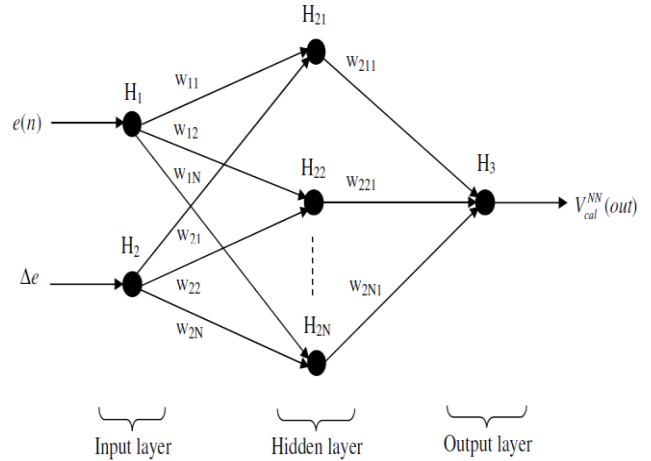

Fig. 3. The Structure of NN for proposed method.

From Fig. 3, the hidden layer of network is $H_{21}, H_{22}, \dots, H_{2N}$ and the weight of neuron is denoted as w . The weight of neuron from input layer to hidden layer is w_1 and hidden layer to output layer is w_2 . The Back Propagation (BP) neural network training and weight adjustment are used in this paper and it is briefed in the following steps.

The training steps involved in neural network are as follows,

Step 1: Initialize the input, output and weight of each neuron. Here, $e(n)$ and Δe are the inputs of the network and network calculate voltage (V_{cal}^{NN}) is the output of the network.

Step 2: The inputs of training dataset are $e(n)$ and Δe to the classifier and determine the BP error as follows

$$BP_{err} = (V_{cal}^{NN})_{tar} - (V_{cal}^{NN})_{out} \quad (7)$$

In Eq. (7), $(V_{cal}^{NN})_{tar}$ is the target output and $(V_{cal}^{NN})_{out}$ is the network output.

Step 3: Calculate the network output as follows,

$$(V_{cal}^{NN})_{out} = \sum_{n=1}^N w_{2n1} V_{cal}^{NN}(n) \quad (8)$$

$$\text{Where, } V_{cal}^{NN}(n) = \frac{1}{1 + \exp(-w_{1n}e(n) - w_{2n}\Delta e)} \quad (9)$$

Eq. (8) and Eq. (9) represents the activation function of output layer and hidden layer respectively.

Step 4: Adjust the weights of all neurons as $w = w + \Delta w$, where, Δw is the change in weight which can be determined as

$$\Delta w = \gamma \cdot V_{cal}^{NN} \cdot BP_{err} \quad (10)$$

In Eq. (11), γ is the learning rate, usually it ranges from 0.2 to 0.5.

Step 5: Repeat the process from step 2, until BP error gets minimized to a least value i.e.

$$10 \cdot BP_{err} < 1.$$

Once the process gets completed, the network is well-trained and it would be suitable for providing $(V_{cal}^{NN})_{out}$ values for any error voltage.

Hybridization of FLC and NN Bias Voltage

In the hybridization section, the V_{cal} is calculated by hybridized outputs of FLC and NN. Here, a mean operation based hybridization is used for calculate V_{cal} . The mean voltage V_{cal} is calculated as follow.

$$V_{cal} = \frac{V_{cal}^{dF} + (V_{cal}^{NN})_{out}}{2} \quad (11)$$

These mean output voltage V_{cal} is apply to the input of bias voltage generator and it is used to quickly discharge the inverter diodes. The harmonics of inverter output voltage is eliminated by the low pass filter, and then the low pass filter output is applied to injection transformer. The output of injection transformer is the delivered the enhanced voltage of the system. Then the Root Mean Square (RMS) voltage (V_{rms}) of enhanced voltage is calculated as follow.

$$V_{rms} = \frac{V_p}{\sqrt{2}} \quad (12)$$

where, V_p is the peak voltage value. The RMS voltage value is used to estimate the PQ enhancement of the operating system.

IV. RESULT AND DISCUSSION

The proposed NFC based UPQC enhancement controller is implemented in MATLAB version 7.12. The parameters that are chosen for implementing the proposed controller are tabulated in TABLE II. The designed FIS structure for the proposed controller is given in fig 4 and the NN performance of Regression, validation and training state are shown as follows

TABLE II: IMPLEMENTATION PARAMETERS.

Parameters	Values
DC Voltage (V_{dc})	$\pm 230V$
Reference Voltage (V_{ref})	$\pm 230V$
Error Voltage ($e(n)$)	-230 V to +230 V
Change of Error Voltage (Δe)	-230 V to +230 V
Number of Hidden Neurons (H_N)	20

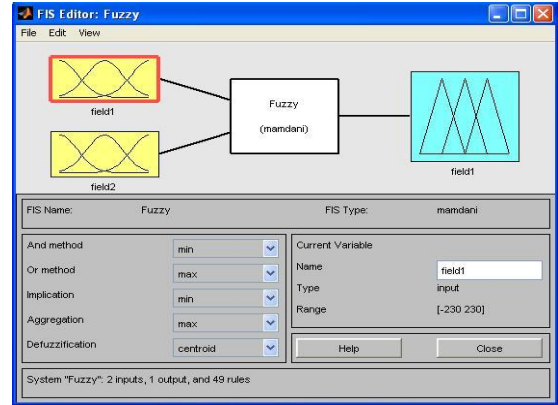
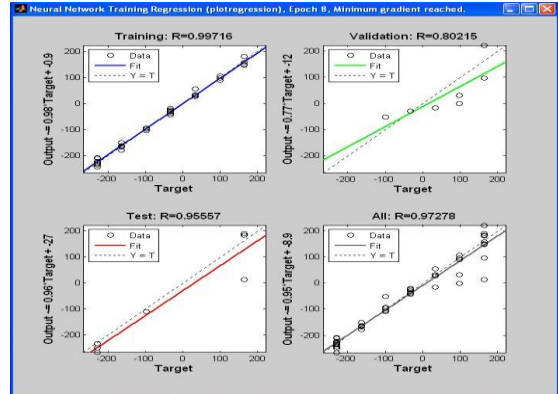
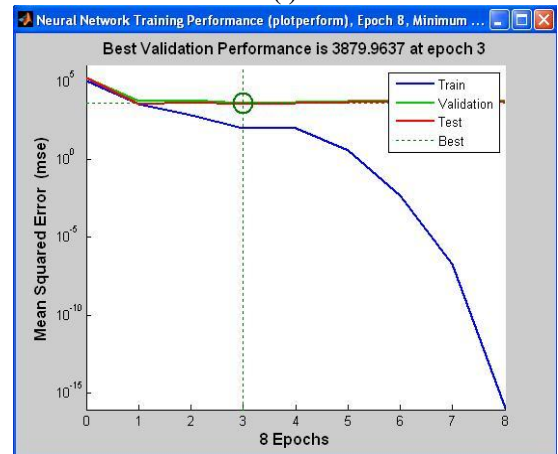

Fig. 4. Structure of designed FLC.



(i)



(ii)

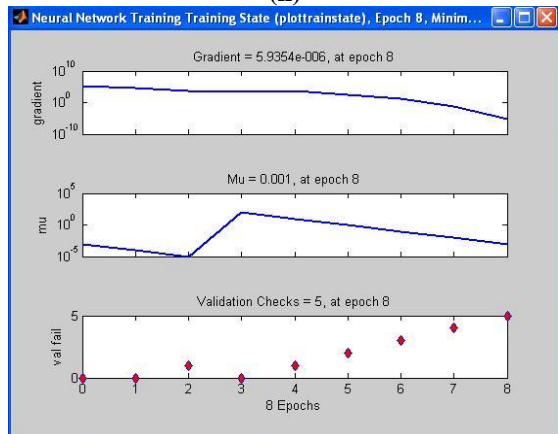

(iii)

Fig. 5. NN Performance plots (i) regression analysis, (ii) network validation performance and (iii) training state

In the implementation, the PQ problem is made to arbitrary

level at different time instants such as $T=0.02\text{sec}$, $T=0.03\text{sec}$, $T=0.09\text{sec}$, $T=0.15\text{sec}$ and $T=0.17\text{sec}$. The reference voltage, line voltage with PQ problem at the defined time instants and line voltage with enhanced PQ are illustrated in Fig. 6, 7, 8, 9, 10 and 11.

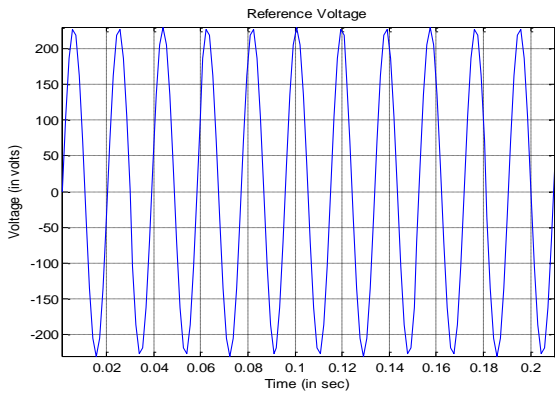

Fig. 6. Reference voltage

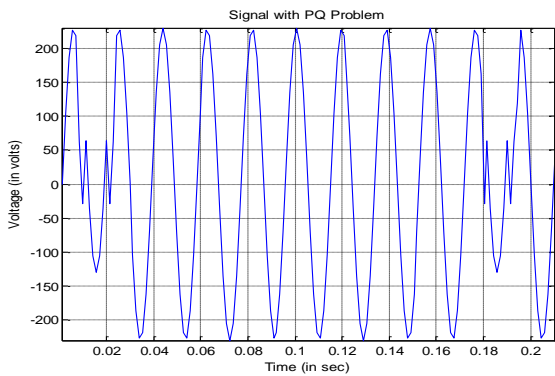

Fig. 7.a. Line voltage with PQ problem at $T=0.02\text{ sec}$.

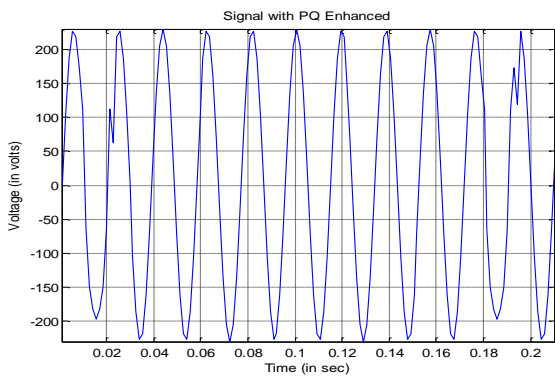

Fig. 7.b. Line voltage with enhanced PQ at $T=0.02\text{ sec}$.

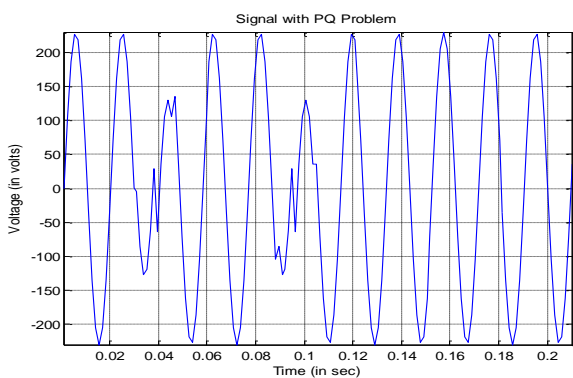

Fig. 8.a. Line voltage with PQ problem at $T=0.03\text{ sec}$.

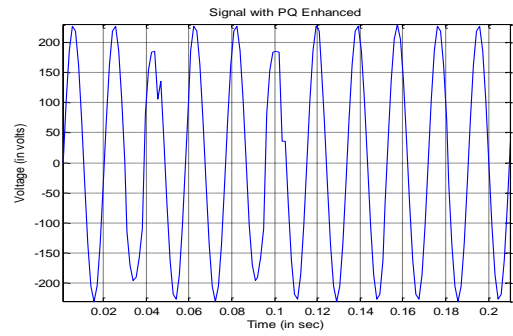

Fig. 8.b. Line voltage with enhanced PQ at $T=0.03\text{ sec}$.

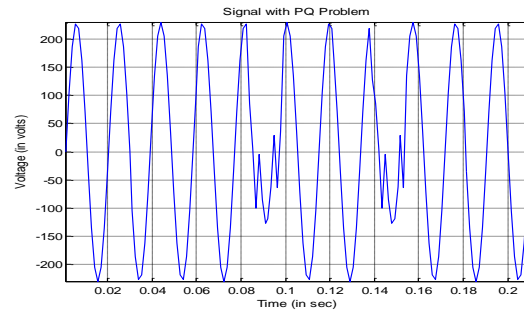

Fig. 9.a. Line voltage with PQ problem at $T=0.09\text{ sec}$.

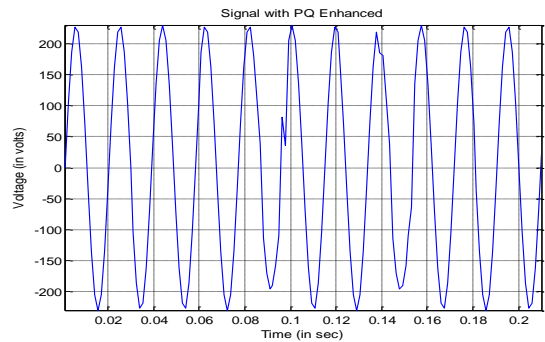

Fig. 9.b. Line voltage with enhanced PQ at $T=0.09\text{ sec}$.

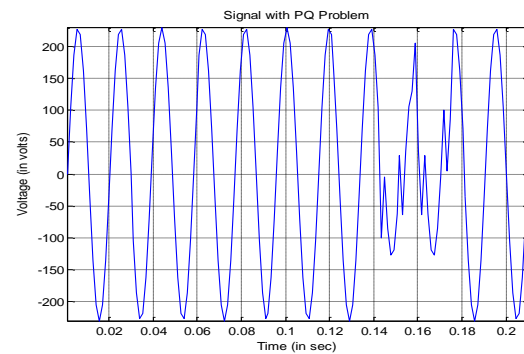

Fig. 10.a. Line voltage with PQ problem at $T=0.15\text{ sec}$.

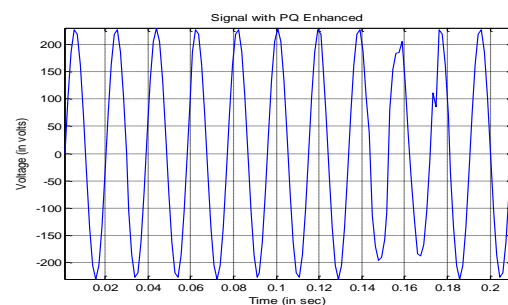

Fig. 10.b. Line voltage with enhanced PQ Problem at $T=0.15\text{ sec}$.

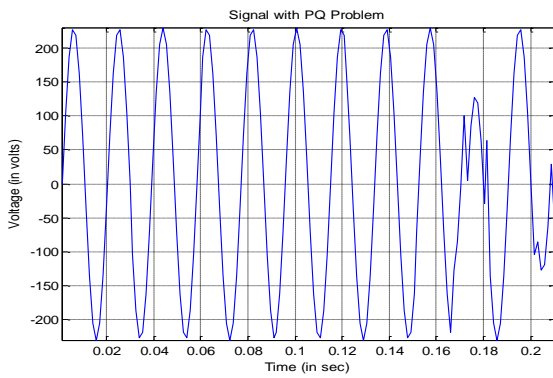

Fig. 11.a. Line voltage with PQ problem at T=0.17 sec.

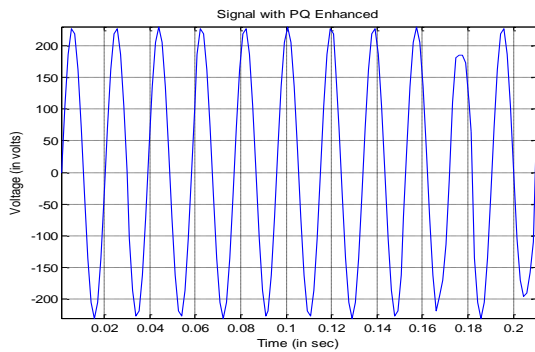

Fig. 11.b. Line voltage with enhanced PQ at T=0.17 sec.

From the above illustrations, the performance of the proposed controller has been observed. It can be visually seen that PQ affected line voltage has been enhanced using the proposed controller to a remarkable level. However the performance of the technique is further substantiated by analyzing the process only with NN-based controller and then with FLC. Hence achieved RMS voltages of FLC, NN-based controller and Proposed NFC for different time instants are tabulated below.

TABLE III: RMS VOLTAGES FROM NFC, NN-BASED CONTROLLER AND FLC AFTER THE ENHANCEMENT OF PQ AT DIFFERENT TIME INSTANTS

Time Instant (in sec) at which the PQ issue occurs	RMS Voltage (in Volts) when PQ issue occurs	RMS Voltage (in Volts) after PQ enhancement		
		NFC	NN-based Controller	FLC
0.02	60	127	110	120
0.03	88	131	124	127
0.09	88	134	124	127
0.15	21	85	71	74
0.17	92	131	120	124

In the executing the proposed controller, the reference voltage has been made to set 163 RMS volts. But when the PQ problem is made to occur in the defined time instants, the RMS voltage gets decreased. The proposed controller enhances the PQ and brings the line RMS voltage to the reference voltage level (reference voltage is the voltage to be maintained). TABLE III describes the performance by comparing the line voltage level before and after enhancing the PQ using proposed NFC, NN-based controller and FLC.

The performance deviation of the NFC is analyzed with FLC and NN-based controller. The performance deviation between NFC and NN-based controller can be calculated as follows

$$Deviation (\%) = \frac{V_{rms}^{NF} - V_{rms}^{NN}}{V_{rms}^{NF}} \times 100$$

Similarly, the performance deviation can also be calculated between NFC and FLC for different instances of occurrence of PQ issues.

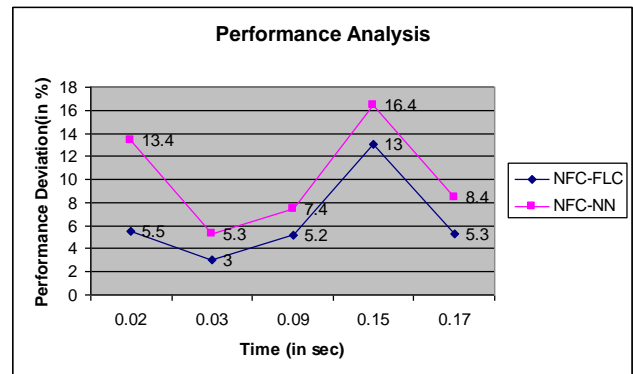

Fig. 12. Performance analysis of NFC with FLC and NN-based controller.

From Fig.12, it can be seen that the performance of proposed controller deviates positively at a rate of 5.5% rather than FLC and 13% rather than NN-based controller at T=0.02sec. Likely, the performance deviation of the proposed technique achieves positive rate in solving all the defined instants of occurrences of PQ issues. Hence it can be shown that the proposed controller has achieved a remarkable level of performance in solving the PQ issue.

V. CONCLUSION

In the paper, we proposed an enhanced UPQC and NFC for maintaining the PQ of power operating device. The proposed controller was implemented and the results were analyzed with relative techniques. A PQ issue of voltage sag was considered in this paper to evaluate the performance of the proposed controller. Hence, the issue was made to occur in various time instants of the line voltage and it was subjected to the proposed technique. The proposed controller enhanced the PQ of the waveform in a remarkable level. The analysis using performance deviation showed that the PQ can be enhanced greatly when the proposed controller is used in power devices. The comparative results assured the PQ enhancing capability of the proposed controller over the relative controllers. In the future work, other PQ issues will also be considered for further evaluation of the proposed controller.

REFERENCES

- [1] M. A. Beg, M. K. Khedkar, S. R. Paraskar, and G. M. Dhole, "A novel clarke wavelet transform method to classify power system disturbances," *International Journal on Technical and Physical Problems of Engineering(IJTPE)*, Vol.1, No.4, pp.27-31, 2010
- [2] Omer Gul, "An assessment of power quality and electricity consumer's rights in restructured electricity market in turkey," *Electrical Power Quality and Utilisation, Journal*, Vol.XIV, No.2, pp.29-34, 2008
- [3] T. Devaraju, V. C. Veera Reddy, and M. Vijay Kumar, "Modeling and simulation of custom power devices to mitigate power quality problems," *International Journal of Engineering Science and Technology*, Vol.2, No.6, pp.1880-1885, 2010
- [4] Bulent Vural, Ali Kizil, and Mehmet Uzunoglu, "A power quality monitoring system based on MATLAB server pages," *Turk J Elec Eng & Comp Sci*, Vol.18, No.2, pp.313-325, 2010

- [5] Mohammad Javad Dehghani, "Comparison of S-transform and wavelet transform in power quality analysis," *World Academy of Science, Engineering and Technology*, Vol.50, pp.395-398, 2009
- [6] S. S. Mortazavi, M. Razaz, and E. Khavari, "Power quality improvement using a fuzzy logic control of a series active filter," *Journal of Theoretical and Applied Information Technology*, Vol.19, No.1, pp.55-63, 2010
- [7] M. A. Hannan, A. Mohamed, A. Hussain, and Majid al Dabbay, "Development of the unified series-shunt compensator for power quality mitigation," *American Journal of Applied Sciences*, Vol.6, No.5, pp.978-986, 2009
- [8] S. Deepa and S. Rajapandian, "Voltage sag mitigation using dynamic voltage restorer system," *International Journal of Computer and Electrical Engineering*, Vol.2, No.5, pp.821-825, October 2010
- [9] T. Devaraju, V. C. Veera Reddy, and M. Vijaya Kumar, "Role of custom power devices in power quality enhancement: a review," *International Journal of Engineering Science and Technology*, Vol.2, No.8, pp.3628-3634, 2010
- [10] Thomas E. Grebe, "Application of distribution system capacitor banks and their impact on power quality," *IEEE Transaction on Industry Applications*, Vol.32, No.3, pp.714-719, 1996
- [11] R. Valarmathi and A. Chilambuchelvan, "Harmonic analysis of distributed pv system under high and low irradiance," *International Journal of Engineering and Technology*, Vol.2, No.3, pp.190-193, 2010
- [12] R. D. Patidar and S. P. Singh, "Active and reactive power control and quality management in dg-grid interfaced systems," *ARNP Journal of Engineering and Applied Sciences*, Vol.4, No.3, pp.81-90, May 2009
- [13] Kuldeep Sahay and Bharti Dwivedi, "Supercapacitors energy storage system for power quality improvement: an overview," *J. Electrical Systems*, Vol.10, No.10, pp.1-8, 2009
- [14] S. Sadaippan, P. Renuga, and D. Kavitha, "Modeling and simulation of series compensator to mitigate power quality problems," Vol.2, No.12, pp.7385-7394, 2010
- [15] Yash Pal, A. Swarup, and Bhim Singh, "Star-hexagon transformer supported UPQC," *International Journal of Electrical and Electronics Engineering*, Vol.5, No.1, pp.63-68, 2011
- [16] Woo-Cheol Lee, "A new control scheme for unified power quality compensator-q with minimum power injection," *Journal of Power Electronics*, Vol.7, No.1, pp.72-80, January 2007
- [17] Othmane Abdelkhalek, Chellali Benachaiba, Brahim Gasbaoui, and Abdelfattah Nasri, "Using of ANFIS and FIS methods to improve the UPQC performance," *International Journal of Engineering Science and Technology*, Vol.2, No.12, pp.6889-6901, 2010
- [18] C. Benachaiba, B. Ferdi, S. Dib, and M. Rahli, "Impacts of short-circuit power on hysteresis control of UPQC," *European Journal of Scientific Research*, Vol.37, No.4, pp.525-534, 2009
- [19] M. Hosseinpour, A. Yazdian, M. Mohamadian, and J. Kazempour, "Design and simulation of UPQC to improve power quality and transfer wind energy to grid," *Journal of Applied Sciences*, Vol.8, No.21, pp.3770-3782, 2008
- [20] M. Davari, S. M. Aleemran, H. Nafisi, I. Salabeigi, and G. B. Gharehpetian, "Modeling the combination of UPQC and photovoltaic arrays with multi-input single-output DC-DC converter," *IEEE International Conference on Industrial Technology*, 2009
- [21] Ahmad Esfandiari, Mostafa Parniani, Hossein Mokhtari, and Ali Yazdian-Varjani, "Power quality improvement of an electric arc furnace using a new universal compensating system," *Journal of Power Electronics*, Vol.6, No.3, pp.195-204, July 2006
- [22] Amit Kumar Jindal, Arindam Ghosh, and Avinash Joshi, "Interline unified power quality conditioner," *IEEE Transactions on Power Delivery*, Vol.22, No.1, pp.364-372, January 2007
- [23] T. Lachman, A. P. Memon, T. R. Mohamad, and Z. A. Memon, "Detection of power quality disturbances using wavelet transform technique," *International Journal for the Advancement of Science & Arts*, Vol.1, No.1, pp.1-13, 2010
- [24] N. Radhakrishnan and M. Ramaswamy, "A fuzzy based power quality enhancement strategy for AC-AC converters," *International Journal of Engineering Science and Technology*, Vol.2, No.4, pp.553-558, 2010
- [25] Darly Sukumar, Vanaja Ranjan, and Benjamin Justus Rabi, "FLC based adjustable speed drives for power quality enhancement," *Serbian Journal of Electrical Engineering*, Vol.7, No.2, pp.217-229, November 2010
- [26] Yash Pal, A. Swarup, and Bhim Singh, "A control strategy based on UTT and I Cos Φ theory of three-phase, fourwire UPQC for power quality improvement," *International Journal of Engineering, Science and Technology*, Vol.3, No.1, pp.30-40, 2011
- [27] M. Siah, M. Najafi, M. Hoseynpoor, and R. Ebrahimi, "Design and simulation of UPQC to improve power quality and transfer power of photovoltaic array to grid," *Australian Journal of Basic and Applied Sciences*, Vol.5, No.3, pp.662-673, 2011
- [28] Leakage current discharging characteristics of capacitor is referred from the link <http://www.rubycon.co.jp/cn/products/pc-con/img/t03.gif>
- [29] V. Suresh Kumar, D. Kavitha, K. Kalaiselvi, and P. S. Kannan, "Harmonic mitigation and power factor improvement using fuzzy logic and neural network controlled active power filter," *Journal of Electrical Engineering & Technology*, Vol.3, No.3, pp.520-527, 2008



M. Vishnuvardhan obtained his B Tech degree in Electrical and electronics engineering from JNT University, Hyderabad. Then he obtained his M Tech degree in Power systems and Industrial drives from JNT University, Anantapur. Currently, he is pursuing PhD in the subject of power systems operation and control, topic area is Power quality and control, in EEE Department, in S.V. University, tirupathi



Dr. P. Sangameswararaju received Ph.D from S.V. University, Tirupathi, Andhra Pradesh. Presently he is working as Professor in the Department of Electrical and Electronics Engineering, S.V. University. Tirupathi, Andhra Pradesh. He has about 50 publications in National and International Journals and Conferences to his credit. His areas of interest are in power system Operation & control and Stability